



**Thin Tech®
Installation Manual**



Thin Tech[®]

Glen-Gery Thin Tech is a mechanical support and spacing panel for thin masonry veneers. The strongest, most durable thin veneer panel system ever designed. Each thin brick, tile or stone is supported by our patented support ties that mechanically interlock the masonry veneer to the panel.

Advanced features:

Provides barrier rust prevention while light color helps reflect and evenly distribute heat

Stucco embossed texture provides a built-in weep system on both sides of panel for moisture control

High fastener pull-through strength for panel support and integrity

Lightweight design reduces footings and lintel requirements

Cost-efficient wall design and reduced labor costs

26-gauge steel protected by a G90 galvanized coating plus a thermal set coating

Patented support tie configuration placed on a 76 degree angle

THIN TECH® INSTALLATION MANUAL

Table of Contents

20 Helpful Tips and Tricks for Thin Tech Installation	4
Getting to Know the Glen-Gery Thin-Tech System	6
Support Tie Spacing Options (Table 1).....	6
System Components and Estimating.....	6
Recommended Fastener Length (Table 2)	7
Pre-Installation Essentials	8
Storage and Handling/Usage Restrictions	8
Evaluation of Substrate	8
Surface Tolerances.....	8
Air Barrier and Drainage System Components	8
Preparation	9
Drainage Mat Installation (Required for Exterior <i>Classic</i> Applications)	9
On-Site Inventory	9
Panel Installation	9
Tools and Equipment	9
Starter Angle Installation	9
Determining the Position of the Starter Angle	9
General	9
Corner Support Installation	10
Thin Tech Panel Installation	10
Installing the First Row.....	10
Recommended Fastening Pattern (Figure 5)	12
Fastening Panels	12
Checking Level.....	12
Accommodating Material Movement.....	12
Shim Installation	13
Installing the Second Panel Row	13
Brick/Stone Installation	13
Tools and Equipment	13
Installing Veneer Units	13
Recommended Adhesive Quantity (Table 4)	13
Cutting Units	15
Installing a Soldier Course.....	15
Installing Weeps or Air Vents.....	15
Mortar Installation	16
Materials and Tools	16
Batching and Mixing.....	16
Beginning Mortar Application.....	16
Striking/Tooling the Joints	17
Cleaning the Veneer.....	17
Appendix A – Mortar Estimating Table.....	18
Appendix B – Determining the Base Starter Angle Position.....	19
Appendix C – Thin Tech Corner Support Installation	20



20 Helpful Tips and Tricks for Thin Tech Installation

These instructions describe and illustrate the steps involved in installing Glen-Gery Thin Tech Wall systems. The purpose is to provide detailed information and how-to tips that will simplify the installation process.

Glen-Gery shall not accept any liability or responsibility under its written warranty for failure caused by applications that do not meet Glen-Gery's minimum requirements for proper installation.

Building codes and regulations vary throughout the country. Be sure to check local code requirements.

Recommendations and requirements are outlined throughout this guide. Any deviations from these requirements should be approved in writing by Glen-Gery Corporation.

Top Installation Tips

Read the complete installation guidelines before beginning your project.

1. **Plan for waste.** A minimum waste/unplanned usage factor of 3-5% is suggested for all materials unless noted otherwise.
2. **Select appropriate support tie spacing (coursing).** For 2-1/4 in. high brick, use panels with 2-11/16 in. support tie spacing to achieve or match traditional (3 courses to 8 in.) brick coursing. Panels with 2-5/8 in. support tie spacing (3/8 in. mortar joints) are available and acceptable for applications where coursing need not match traditional masonry.
3. **Edges are sharp!** Wear gloves when handling metal panels and accessories.
4. **Cut masonry with care.** Use a wet saw (tile saw or brick saw with diamond blade and with a steady circulation of water) or dust collecting saw for cutting and an electric angle grinder for shaping masonry units. During the cutting procedure, a NIOSH N95 dust mask, hearing and eye protection should be worn at a minimum.

Clay brick and other masonry units contain crystalline silica and the use of a NIOSH N95 respirator is strongly recommended however, you should refer to your Federal, State and Local guidelines as well as your company's Respiratory Protection Program and the Safety Data Sheet for additional information.
5. **Begin with a flat and rigid substrate.** Acceptable substrates include gypsum sheathing, cement board, OSB, exterior grade plywood and rigid insulating foam meeting specified requirements. Composite shims may be used to compensate for wall imperfections.
6. **Level up.** It is very important to keep panels and accessories level at all times.
 - Use a long level to check if entire course is level.
 - Check level in both directions on each corner panel.
 - Placing 3/8 in. spacers between corner units may help to keep them level while the adhesive sets.
 - a) If a masonry unit is not level, try substituting another masonry unit to optimize fit and aesthetics.
7. **Mix it up.** Veneer units should be selected from 2 to 3 boxes or pallets at one time to achieve a uniform distribution of normal variations in color range.
8. **No loose ends.** Use Thin Tech shims to provide support to vertical *Elite* panel edges that extend more than 2 inches beyond a channel. The panel edges will be easier to fasten and won't be pulled inward toward the substrate.
9. **Handle with care.** Avoid damage to veneer units by carrying cartons from underneath. Do not carry units by strapping, drop cartons, stack cartons more than six high or double stack pallets.
10. **Use longer support ties for larger, thicker units.** 5/8 in. support ties are recommended for cast/natural stone as well as thin brick 3/4 in. thick or more with a height of 3-5/8 in. or more. For other thin brick units, 3/8 in. support ties are adequate.
11. **Fastening fundamentals.** Pre-punched holes in the Thin Tech Panels are spaced to allow fastener installation 16 in. horizontally and 8 in. vertically, resulting in 24 fasteners per panel and ensuring a minimum of 1 fastener per sq. ft.
 - When fasteners are not placed in channels or pre-punched holes, they should align with the bottom of support ties, so that the fastener heads are in the mortar joints and do not interfere with brick placement.
 - Vertical panel edges should begin and end on a stud or structural member.
 - Individual fasteners should be installed along the edges of each panel and should not bridge two panels.
12. **Use silicone adhesive for cast/natural stone units.** Glen-Gery Heavy Duty Adhesive is typically recommended for thin brick. Additional independent testing may be completed to determine if the Glen-Gery adhesive may be used or silicone may be applied.
13. **Mind the gap.** Leave 1/16 to 1/8 in. space between the vertical edges of adjacent panels in each row to allow for panel expansion.
14. **Establish unit layout and alignment before installation.** Lay the first two courses dry to ensure proper alignment, joint spacing and minimize cut units prior to adhering to the panel surface. Complete the first two courses of masonry units to serve as a guide for alignment of vertical joints as installation moves up the rest of the wall. Examine the work from a distance occasionally to ensure that the spacing of brick is consistent.

Substrate	Minimum Thickness (in.)
Exterior Grade Gypsum Sheathing Glass Fiber Mat-Faced Sheathing Cement Board	1/2
Closed-Cell Insulating Rigid Foam*	1/2
OSB	7/16
Exterior Grade Plywood	3/8

*ASTM C578, or ASTM C1289 (min. 15 psi compressive strength and min. 1.30 lb/cu. ft. density)

15. **Flatten support ties for soldier courses.** To install brick in a vertical orientation, flatten rows of support ties that will be behind (but not above or below) the soldier course so that the soldier brick can lie flat against the support panel.
16. **Secure weep vents with adhesive.** For *Elite* panels, install Glen-Gery Thin Tech weep vents into open head joints above all starter angles for proper water drainage and ventilation. Adhere the back of the air vent to the panel with a dab of supplied adhesive.
17. **Make mortar easy.** Reducing the sand content to the minimum ASTM proportions for Type S or N has proven to ease mortar installation with a grout bag. Portland cement-lime mortar has also proven to be easier to install with a grout bag than preblended mortar.
18. **Remove lumps from dry mortar materials.** Screening the sand and cement prior to mixing may help prevent clogs that block the mortar bag or gun.
19. **Don't tool joints too early.** Mortar should not be struck/tooled until it is dry enough to fall away clean and tooling results in a dull, gritty finish (not wet and shiny).
20. **Predrill concrete and masonry substrates.** Use a 5/32 in. diameter bit to predrill concrete/masonry substrates and ease Thin Tech fastener installation.



Getting to Know the Glen-Gery Thin-Tech® System

Glen-Gery Thin Tech Wall System includes a patented mechanical support and spacing panel for thin brick and stone veneer on wall substrates, backed by one of the largest brick manufacturers in the country and one of the largest building products companies in the world. Constructed with high-grade, G90 galvanized steel and a thermal set protective coating, Thin Tech panels provide ultimate durability and strength. This new technology is clean and simple to install with only a few basic tools.

Glen-Gery Thin Tech veneer installation is completed in 3 parts; Panel, Brick and Mortar.

Glen-Gery Thin Tech features two types of heavy gauge metal support panels for maximum design flexibility and long lasting performance.

Classic: A panel that is ideal for interior applications or installed over a Glen-Gery Drainage Mat for exterior applications.

Elite: A panel with a ribbed profile that creates an integrated drainage and air flow cavity system. These heavy gauge support panels are suitable for exterior and interior usage.

Glen-Gery Thin Tech provides a patented support tie that creates mechanical interlock between the mortar, brick and the panel. The stucco embossed texture of both the *Classic* and *Elite* panel allow moisture to drain from either the front or the back of panel.

Glen-Gery Thin Tech has multiple support tie spacing variations and 2 support tie lengths to accommodate the widest variety of veneer sizes.

TABLE 1 – GLEN-GERY THIN TECH MASONRY SUPPORT PANELS SUPPORT TIE SPACING OPTIONS

Unit Height	Support Tie Spacing*	Elite Panel Size (H x W)**	Classic Panel Size (H x W)**	Support Tie Length
2-1/4 in.	2-11/16 in. (3 courses = 8 in.)	48 in. x 48 in.	48 in. x 48 in.	3/8 in. (5/8 in. special order)
2-3/4 in.	3-3/16 in. (5 courses = 16 in.)	48 in. x 48 in.	48 in. x 48 in.	3/8 in. (5/8 in. special order)
3-5/8 in.	4 in.	48 in. x 48 in.	48 in. x 48 in.	3/8 in. and 5/8 in.
7-5/8 in.	8 in.	48 in. x 48 in.	48 in. x 48 in.	5/8 in.
11-5/8 in.	12 in.	48 in. x 48 in.	48 in. x 48 in.	5/8 in.
Non-standard coursing 2-1/4 in.***	2-5/8 in.	47-1/4 in. (H) x 48 in. (special order)	47-1/4 in. (H) x 48 in. (special order)	3/8 in. (5/8 in. special order)

*Additional sizes available via special order.

**Nominal Dimensions. Actual dimensions may vary by ±1/8 in.

***Non-standard coursing with 3/8 in. mortar joints (3 courses = 7-7/8 in.).

For 2-1/4 in. high brick, panels with 2-11/16 in. (3 courses to 8 in.) support tie spacing matches traditional brick coursing. Panels with 2-5/8 in. support tie spacing are available for applications where coursing need not match traditional masonry. Stone veneer heights may vary, affecting joint sizes.

Support Tie Lengths:

3/8 in. for thin brick ≤3/4 in. with a height <3-5/8 in.

5/8 in. for cast/natural stone (and thin brick ≥3/4 in. thick with a height ≥3-5/8 in.)

System Components and Estimating

A minimum waste/unplanned usage factor of 3-5% is suggested for all materials unless noted otherwise. For special order items a minimum of 8-10% waste is suggested.

Proper waste factors are affected by project/site management and installation experience and are the responsibility of the installer.

Thin Tech Support Panel

Mechanical support and spacing panel for thin brick and stone veneer on wall substrates.

Calculate square footage of wall area to be covered by each Thin Tech panel size (omit large

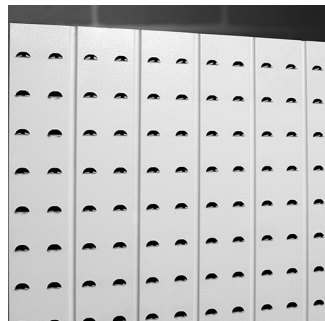

Thin Tech Support Panel

openings) and divide by 16 for the number of support panels needed. Add a minimum of 2% for waste/unplanned usage. Waste/unplanned usage will vary based on the number and size of openings and building configuration.

Thin Tech Corner Support

Accommodates panel attachment at exterior corners where vertical panel edges/channels do not align with studs. 6 in. by 6 in. x 48 in. (L).

Calculate the total height (in ft.) of all corners and returns where corner supports will be used and divide by 4 to obtain the number of corner supports.

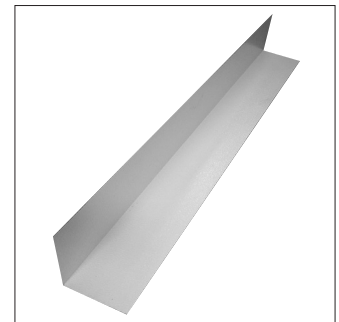

Corner Support

Thin Tech Starter Angle

Required at the base of walls, above openings and horizontal movement joints to facilitate moisture control. The starter angles are 10 ft. long and 3 in. high with widths (depth) in 1 in. increments to accommodate various assembly thicknesses.

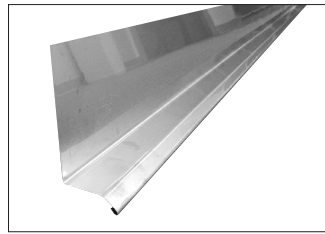

Starter Angle

For each story, add the length (in ft.) of wall to be covered by Thin Tech system to the width of all doors, windows and other openings. Divide by 9 for the approximate number of the starter angles required. A minimum 10 % waste/unplanned usage factor is recommended. Opening sizes will affect final quantity required.

Thin Tech Spacer

Reusable component that provides recommended 3/4 in. spacing below *Elite* panels for drainage and airflow.



Thin Tech Spacer

Thin Tech Fasteners

#10 ceramic coated screws available in multiple lengths for attachment to wood, concrete, masonry or steel. Fastener length dependent on assembly specifics, such as thickness of continuous rigid insulation. Contact Glen-Gery representative regarding alternate fasteners or applications over rigid insulation more than 2 in. thick.



Fasteners

Sum the number of fasteners needed for each length and type (wood/concrete/masonry or steel) and add at least 5% for waste/unplanned usage:

Panels – 24 fasteners recommended (minimum 1 per sq/ft). Multiply number of panels that use each fastener length and type by 24.

Starter angles, flashing, shims and corner supports – Multiply linear feet that use each fastener length and type by 1.5.

TABLE 2 – RECOMMENDED FASTENER LENGTH^a

Continuous Insulation Thickness	Application		
	Steel Framing ^b	Wood Framing ^b	Concrete or Masonry
0	1-1/2 in.	2-1/4 in.	1-1/2 in.
1	2-1/2 in.	3-1/4 in.	2-1/4 in.
2	3-1/2 in.	4-1/4 in.	3-1/4 in.
3	4-3/4 in.	5-1/2 in.	4-1/4 in.
4	5-3/4 in.		

^aUse 1-1/2 in. self-drilling fasteners to secure panels to corner supports

^bFor 7/16 in. to 5/8 in. sheathing thickness

Minimum fastener lengths above are based on minimum embedment requirements.

Fasteners longer than shown are needed when installed diagonally at inside corners, see Appendix C for recommended minimum lengths.

Glen-Gery Drainage Mat

Drainage and ventilation system for use with exterior *Classic* panel applications (3. 3 ft. [H] x 61.5 ft. [L] roll).

Calculate square footage of wall to be covered by Thin Tech (do not omit openings) and divide by 200 sq. ft. for the number of rolls needed.

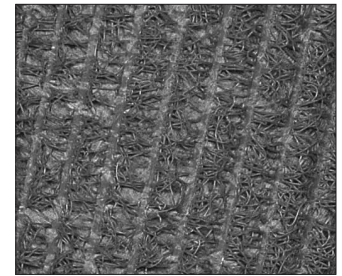

Drainage Mat

Transition Tape

Self-adhering, water-resistant tape for use as a transition material between water-resistive barrier and starter angle flashing. Available in 75 ft. rolls, 3 in. or 6 in. wide. Suitability/compatibility with other products must be confirmed by manufacturer.



Transition Tape

Divide linear feet of starter angle by 75 for number of rolls.

Thin Tech Air Vent

Replaces mortar to permit drainage from Thin Tech system and airflow into *Elite* applications. Available in 4 ft. lengths. Can be cut on-site to desired height for use as vertical weeps. (3/8 in. x 1/2 in. x 4 ft. [L])

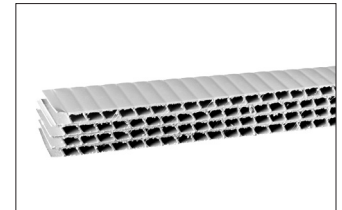

Air Vent

Used as vertical weep vents in head joints every 24 inches – multiply linear feet of starter angle by 2.25 (or specified weep height in inches) and then divided by 96.

Used as horizontal air vent (*Elite* panels – optional) – Linear feet of air vent should be equal to Starter Angle.

Thin Tech Shim

Required to ensure panel edge support where cutting panels results in vertical edges extending more than 2 in. beyond a channel (e.g., openings and corners). (1-1/4 in. [W] x 4 ft. [L])

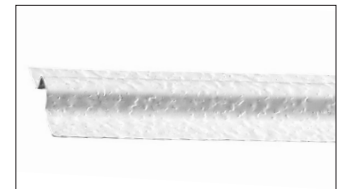

Shim

Shims may be required at ends of walls, corners, openings or returns.

Multiply the total height (in ft.) of shim locations and divide by 4 for number of shims needed (15% to 20% of the number of Thin Tech panels for most projects). Quantities vary based on number and configuration of building and openings.

Thin Brick Adhesive

Provides initial attachment between thin brick and panels. One 28 oz. cartridge will cover approximately 15 sq./ft. for modular thin brick stretchers.



Thin Brick Adhesive

Cast/Natural Stone (Silicone) Adhesive

Provides initial attachment between cast/natural stone units and panels. Primer may be required for cast/natural stone applications.

Multiply number of Thin Tech panels to be covered by cast/natural stone by 2 for number of 10 oz. cartridges of Cast/Natural Stone (Silicone) Adhesive.



Cast/Natural Stone (Silicone) Adhesive

Cast/Natural Stone Primer

Contact stone supplier or Glen-Gery representative to determine if primer is required. Used with silicone adhesive; enhances bond between veneer unit and panel when applied to back of veneer unit prior to installation.

Divide number of support panels to be covered by stone by 14 (or multiply stone sq. ft. by 0.0044) for required number of 30 oz. cans of primer.

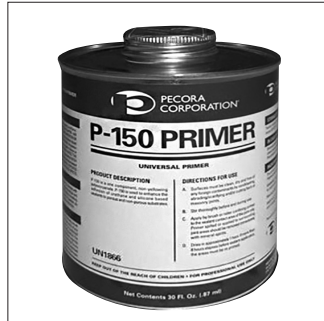

Cast/Natural Stone Primer

Glen-Gery Color Mortar Blend

A blend of Portland cement, lime and approved pigments that meets ASTM-C270 Type N or S specifications. Fills joints between brick units enhancing strength and resisting water penetration. 1 cu. ft. per bag (72 lbs.).

Number of bags (assuming 1/2 in. modular size brick) mixed with 2-1/4 parts sand equals veneer sq. ft. divided by 112. See Appendix A or [Thin Brick Product Profile](#) for other sizes and widths.

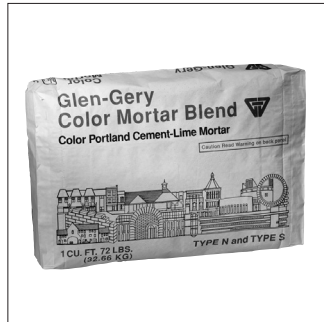

Glen-Gery Color Mortar Blend

Note: The number of flat units per sq. ft. or corner units per linear ft. can be found for all brick sizes in the Thin Brick Product Profile.

TABLE 3 - THIN BRICK COVERAGE

Thin Brick Size	Thin Brick Per square foot	Corner Units Per linear foot (vertical)
Queen	5.63	3.75
Modular	6.75	4.5
Engineer Modular	5.63	3.75
Handmade Oversize	5	3.75
Norman	4.5	4.5
Utility	3	3

PRE-INSTALLATION ESSENTIALS

Storage and Handling/Usage Restrictions

- Review SDS for all materials before use and comply with prescribed measures.
- Store Glen-Gery Thin Tech Panels, masonry units, mortar, and accessories off the ground to prevent contamination by mud, dust or other materials likely to cause staining or other defects. Panels must be stored to prevent distortion and kept dry before installation.
- Protect materials from contamination, moisture, freezing, overheating or other damage. Keep all materials covered with a non-staining waterproof membrane material when necessary to protect from elements. Panels and accessories should be covered at all times prior to installation.
- Store different types of materials separately. Store adhesive and mortar additive above 32° Fahrenheit (F) and below 86°F temperatures. Store and dispose of solvent-based materials and materials used with solvent-based materials, in accordance with requirements of local authorities having jurisdiction.

Evaluation of Substrate

- Confirm products and installations meet appropriate building code requirements.
- Glen-Gery Thin Tech must be installed over stable, structurally sound and plumb walls designed for a maximum deflection of L/360. Substrate shall meet all applicable local building code requirements. Obtain owner or engineer's approval prior to panel installation.

“L”= stud length (in inches). For an 8 ft. stud, 96/360=0.267 inches of deflection at the mid-span of the stud.

Note: Other mortars have been used successfully, but may affect system warranty. Issues such as inconsistent mortar color and difficulties using a mortar bag have been experienced with some prepackaged mortars.

Modified mortars meeting ANSI A118.4 or A118.15 are recommended to reduce the potential for cracking where veneer in stack bond results in continuous joints longer than 32 in.

Thin Brick

Glen-Gery offers thin brick in the widest variety of colors, textures and overall appearance for endless design possibilities. Thickness may be 1/2 in., 3/4 in. or 1 in. depending on thin brick product specified.

Number of flat units of each color and size equals wall area (in sq. ft.) to be covered with flats divided by the number of brick per sq. ft. Minimum 5% waste factor recommended.



Thin Brick

- Sheathing shall be approved type for installation and installed per manufacturer's recommendations and specifications.

SURFACE TOLERANCES

- Veneer surface will follow the contour of the wall. Substrate (i.e., sheathing, masonry, concrete or continuous rigid insulation) variation from plane must not exceed 1/4 in. in 10 feet. Notify the owner of varying conditions and correct deficiencies prior to starting work.

AIR BARRIER AND DRAINAGE SYSTEM COMPONENTS

- Code approved flashing materials must be properly installed at all terminations, penetrations and material transitions.

- Air barriers, water-resistive barriers, drainage mats, starter angles, flashings and trims, as well as rigid insulation (when required) must be installed as per detail drawings and in accordance with code requirements prior to installation of Thin Tech panels.
- Minimize water penetration caused by roof run off, gutters and downspouts – include roof kick-out flashings where appropriate. If there are concerns regarding the integrity of the wall or water management principles, contact the appropriate owner, registered design professional or builder for corrective measures.

Preparation

DRAINAGE MAT INSTALLATION IS REQUIRED FOR ALL EXTERIOR CLASSIC SUPPORT PANEL APPLICATIONS

GLEN-GERY DRAINAGE MAT INSTALLATION

(Complete installation instructions available separately. For other drainage mats follow manufacturer's installation instructions)

- Install Glen-Gery Drainage Mat where specified, after windows and doors have been properly installed and flashed.
- Start at the base of the wall, immediately above horizontal leg of the starter angle. Unroll Glen-Gery Drainage Mat from right to left with the fabric flap at the bottom, with the (blue) polymer matrix against the water-resistive barrier (WRB) and the fabric facing the exterior of the building. Attach with corrosion resistant staple or cap nail every 3 sq. ft. (approx. 16 in. x 24 in.).
- On the first (bottom) course only, unfold the fabric flap and tuck it between the WRB and the (blue) polymer matrix.
- On subsequent courses, butt the (blue) polymer material together tightly without overlapping and pull the fabric flap over the course below (shingle style) and staple.
- On top course, invert the roll and unroll left to right with the fabric flap at the top. When the top course is inverted, trim the bottom edge of the drainage mat if necessary so that it does not overlap the course below.
- Unfold the fabric flap and tuck it between the (blue) matrix and the WRB to create an insect screen.

Trimming drainage mat away from the wall is recommended to avoid damaging the WRB.

On-Site Inventory

Review project specifications, detail drawings and purchase orders and verify that:

- All materials in the work order have been delivered
- All materials are in good condition
- The correct mortar, brick and/or stone has been delivered
- The correct panels, fasteners and adhesive have been delivered
- Delivered quantity will cover the area of installation

PANEL INSTALLATION

Tools and Equipment:

ESSENTIALS

- Measuring tape
- Screw gun or drill
- #2 Square drive bit
- Approved Glen-Gery Fasteners
- Traditional level or laser level (4 ft. preferred)
- Grinder, tin snips or power shears
- Pencil or marker
- Safety glasses
- Earplugs
- Gloves

OPTIONAL

- Extension cords
- Chalk line
- Hammer stapler
- Utility knife
- Screw pouch
- Wheelbarrow
- Ladders, scaffold, or jacks (OSHA approved)
- Sawhorse and support planks
- Template for cutting or holding brick

Pre-construction meetings shall cover all decisions pertaining to design so that wall framing assembly, air and water barriers, drainage mat, and rigid insulation are properly installed and suited for the installation of Glen-Gery Thin Tech support panels.

Starter Angle Installation

The starter angle assists in directing water away from walls and may support the brick above; it must be installed at the base of the wall, above all doors and windows, at material transitions and above horizontal movement joints. Additional flashing is typically required to ensure drainage from other wall areas/materials.

The starter angle can be used to ensure drainage of the Thin Tech system alone, or can be installed behind continuous insulation to drain the entire wall in front of the WRB. Project details and installation schedule must be consulted to determine feasibility of either method.

DETERMINING THE POSITION OF THE STARTER ANGLE

- Determining the proper height of the starter angle on the wall, as well as the proper depth of the starter angle is important to ensure proper coursing as well as wall drainage. Additional information is available in Appendix B, which includes recommendations for determining the location of the starter angle in order to reduce the need for cut units above openings.

GENERAL

- Observe the following required locations and clearances for starter angle placement (exterior applications):
 - Do not install starter angle below grade.
 - Install starter angle at least 4 in. above earth, 2 in. above paved areas and roofs.
 - Install starter angle at least 3/8 in. above doors and windows.
 - At horizontal movement joints, install starter angle with at least a 3/8 in. space below to accommodate movement.
- Do not fasten ends of starter angle where two starter angles are lapped (within lapped area).
- Gaps should be provided where continuous runs of starter angle are butted to accommodate expansion. A maximum interval of 24 ft. is recommended. A 1/8 in. to 1/4 in. gap is needed for each 10 ft. of starter angle length.
- Fold the water-resistive barrier up from the base of the wall (or cut if necessary to install starter angle) and temporarily secure (tape/staple) the edge to hold it out of the way.
- Mark a level line across the wall, at the planned bottom edge of the lowest brick course.
- Align horizontal leg of the starter angle with the level line marked across the wall.

- Fasten starter angle at 8 in. to 10 in. o.c. using Thin Tech fasteners. Install each screw 1-1/2 in. to 2 in. above the horizontal leg of the starter angle.
- When starter angle functions as flashing, overlap ends at least 3 in. and seal horizontal and vertical legs with 2 beads of compatible sealant. Trim hemmed edge of starter angle on one side of lap.
- Apply transition tape to the top edge of the starter angle so that it covers the fasteners and overlaps the substrate, preventing moisture from traveling behind the angle.
- Use preformed starter angle corners, bend or miter cut starter angle to provide continuity at corners (leaving no gaps for water to pass through.) Seal laps at starter angle corners with compatible sealant or cover mitered/abutting edges with transition tape.

Marking the center of studs on the starter angle may be helpful or necessary where water-resistive barrier, drainage mat or continuous rigid insulation is installed over sheathing.

- Mark the center of each stud on the outer edge of the starter angle as they will serve as references for fastening the support panels after the WRB or continuous insulation is installed (see Figure 1).

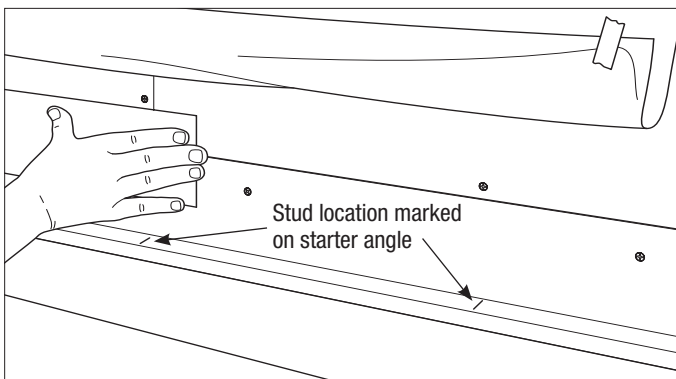

FIGURE 1

- Remove the tape or staple and fold down the WRB so that it overlaps the starter angle.

Starter angle is intended to function as flashing for Thin Tech wall system components alone. When starter angle is installed to direct water from additional wall assembly components, it must be lapped and sealed as described in “Starter Angle Installation” section above.

If starter angle is placed behind continuous rigid insulation, it must have a horizontal leg deep enough to accommodate the rigid insulation, the support panel and the thin brick. Thin Tech starter angle may be installed in front of insulation, provided that 1) the top edge is taped to, or otherwise integrated with the insulation or WRB surface in accordance with manufacturer’s instructions; and 2) other means are provided to address code requirements related to flashing and protection of insulation for the remainder of the assembly.

Corner Support Installation

Thin Tech Corner Supports increase the available area for attachment of Thin Tech panels and should be used to ensure secure attachment where the framing configuration or thickness of continuous insulation prevent alignment of vertical panel edges with studs at corners. Where needed, Thin Tech panels are installed on top of and fastened to corner supports, see Figures 2 and 3. (A shim must be installed to support vertical panel edges more than 2 in. from a channel.)

- Position the corner support vertically, with the 6 in. legs lying flat against and covering the substrate/insulation corner.
- Fasten each side of corner support to stud, at 4 in. from the top and bottom and 8 in. on center vertically.

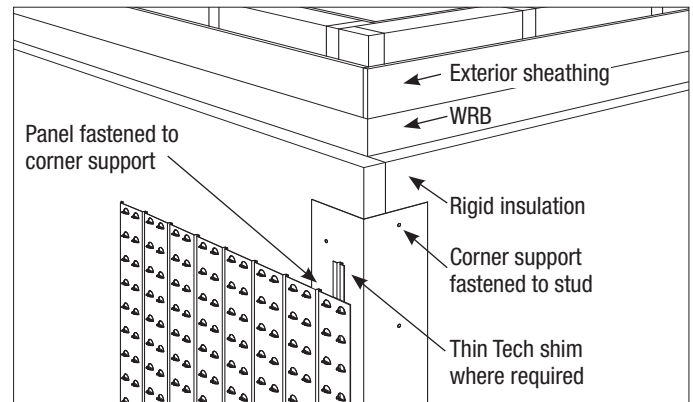

FIGURE 2 (ALSO SEE FIGURE 3 – PAGE 11)

Further guidance related to use of corner supports is included in Appendix C.

Some inside corner configurations may only have a stud behind one side of the corner support. In this case, the corner support may be fastened through the center bend, with a fastener angled to engage the stud.

Thin Tech Panel Installation

Make Sure Panels are Clean and Dry

- Remove moisture and dirt from panels. These will interfere with adhesives and mortar. If necessary, a non-oil based cleaner can be used.

Each of the Thin Tech components contribute to the performance of the system and are not intended to remain on the wall in an unfinished condition for more than a few weeks. Exposure to weathering of unfinished walls, Thin Tech panels or adhesive may lead to corrosion, reduced bond or other issues.

INSTALLING THE FIRST ROW

- Beginning Thin Tech panel installation at an outside corner is recommended. At inside corners, position support panels so that their vertical edges are at least 3/8 in. away from intersecting substrates, panels or veneer surfaces.

Thin Tech shims may be installed at outside corners to help square *Elite* panels at corners (see Figures 2 and 3).

Vertical Alignment

- Vertical edges of full panels should align with studs or other structural members.
- Trim the panel closest to the corner (if necessary), so that the vertical edge farthest from the corner aligns with the center of a stud not more than 48 in. (or panel width) from the corner. This ensures that successive panels in the row align with a stud or structural member.

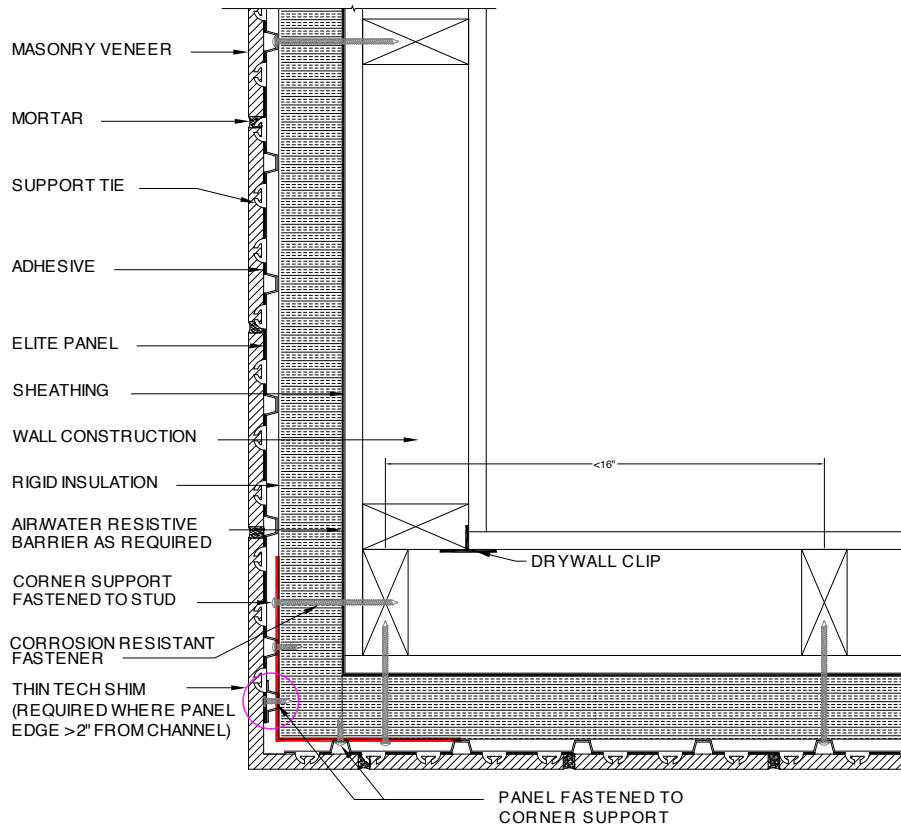

FIGURE 3

- If the vertical panel edge closest to the corner does not align with a stud, trim the panel so that there is a support tie as close to the corner as possible and fasten the panel, within 2 in. of the vertical edge to a Thin Tech Corner Support (see Appendix C for additional information).

Horizontal Alignment

- For *Elite* applications, slide Thin Tech spacers with “GG” logo upright and facing forward, fully onto the bottom edge of first (lowest) row panels, and position panels with the spacer resting on the horizontal leg of the starter angle and vertical edges aligned over studs, see Figure 4. (If Thin Tech spacers are not used, position panels so that their bottom edges are 3/4 in. above the horizontal leg of the starter angle and their vertical edges align over studs.)

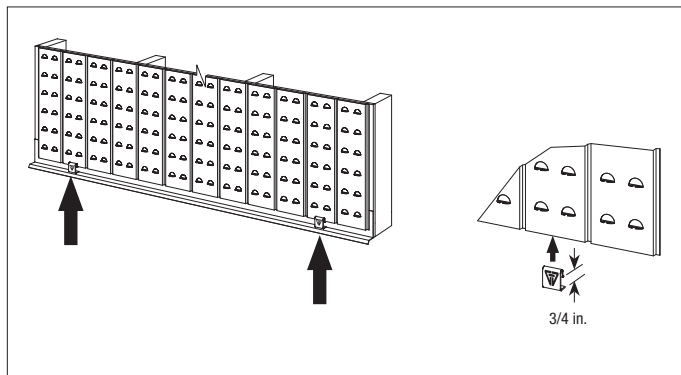

FIGURE 4

Thin Tech spacers are reusable and are more easily removed before fasteners near the bottom of the panel are installed.

- For exterior applications, position panels in the first row so that their bottom edges rest on top of the starter angle and the vertical edges align over studs.
- Where other vertical support for brick is provided, first row *Classic* panels may be trimmed 5/16 in. above the bottom of the panel to omit the joint below the first course of brick.

To ensure proper alignment of coursing at openings, the location of the starter angle should be considered when trimming the bottom row of support ties from panels.

- For exterior applications, weep holes/vents must be placed in vertical head joints a maximum of 24 in. on center horizontally for units 12 in. or less in length and a maximum of 32 in. on center for larger units, as described in “Installing Weeps or Air Vent” section on page 15.

RECOMMENDED FASTENING PATTERN (2-1/4 IN. HIGH UNITS)

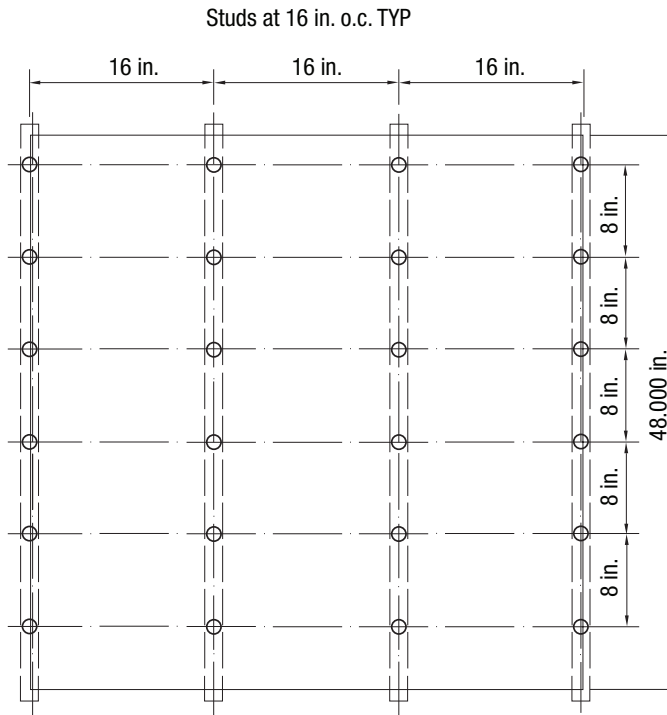

FIGURE 5

FASTENING PANELS

- Recommended fastening pattern is 8 in. vertically and 16 in. horizontally (aligned over studs for proper anchorage) resulting in 24 fasteners per full panel as indicated in Figure 5. A minimum of one fastener per sq. ft. is required for concrete/masonry backing or if an alternate stud/girt spacing is used. Use of fasteners other than those supplied or approved by Glen-Gery will void the system warranty.
- Fasten each panel starting at the center and working toward the edges to help prevent oil canning (bulging). Install additional screws as necessary to ensure uniform panel installation and attachment.
- Fasteners shall extend at least 1-1/4 in. into wood studs, 1 in. into concrete/ masonry substrates, or penetrate metal studs a minimum of 3 threads.
- Install additional fasteners within 8 in. of the tops and bottoms of building walls, spaced no more than 12 in. o.c. horizontally.
- Install additional fasteners within 4 in. of window openings and ends of walls, spaced no more than 8 in. o.c.
- All panels shall be fastened within 2 in. of panel edges aligned over studs or supporting structural members. Where the vertical edge of Thin Tech Elite panel is more than 2 in. from a channel, install Thin Tech shim and fasten for additional support.

CHECKING LEVEL

- Check each panel to ensure that it is level and support ties are aligned horizontally between adjacent panels (see Figure 6). Leave 1/16 to 1/8 in. space between the vertical edges of adjacent panels in each row to allow for panel expansion.
- Complete the first row of support panels working from the corner toward the opposite end of the wall.

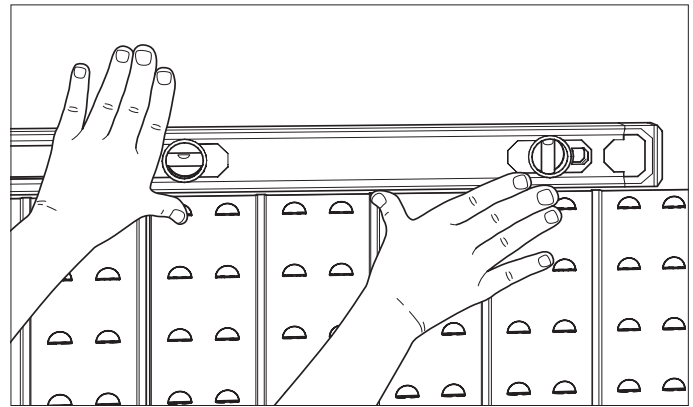

FIGURE 6

ACCOMMODATING MATERIAL MOVEMENT

The spacing of vertical movement joints should not exceed a length to height ratio of 1.5 for a particular wall, or portion of a wall, with a maximum movement joint spacing of 24 ft. Such spacing includes the distance from one movement joint to the next around a corner, with at least one movement joint 2-4 feet from each outside corner.

- To accommodate movements between the substrate, Thin Tech panels and masonry units, leave a minimum 3/8 in. space (continuing through each row of panels and extending the full height of the veneer) at panel edge and apply bond breaker tape (or backer rod) and sealant where stresses related to volume changes are expected, including the following locations:
 - Aligned with, and at least as wide as movement joints in building/substrate
 - Changes in substrate/support condition, wall height or thickness
 - At changes in building materials (such as where stone or brick veneer meets other siding)
 - At movement joints in foundation
 - Within 2 to 4 ft. of outside corners and at inside corners
 - Around the perimeter of doors, windows and openings
 - Vertical expansion joint spacing not to exceed 24 ft., horizontal expansion joint recommended every story with spacing not to exceed 20 ft. vertically
- Leave a 3/8 in. space between support panel edges and intersecting surfaces (walls, substrates, panels) at inside corners to permit veneer expansion and allow room for the support ties at corners.
- Horizontal movement joints must be placed between all starter angles (located above the base starter angle) and underlying materials.

Horizontal movement joints are also recommended at transitions between different types of masonry units on the panels, as well as between Thin Tech panels with different support tie spacings.

SHIM INSTALLATION

- Thin Tech shim installation is required to support vertical cut edges of *Elite* panels that extend more than 2 in. beyond a channel.
- Align edge of Thin Tech shim behind cut edge of panel (with channel open to the exterior) and fasten to wall (see Figure 2). Fasten edge of panel to wall every 8 in. vertically through the channel of the shim.

INSTALLING THE SECOND PANEL ROW

- Rest the second row of panels on top of the first row. Stagger vertical panel joints between rows by beginning each row with panels having different dimensions. Establish stagger by cutting the first panel in every other row of panels to the length required to end at the center of a stud (see Figure 7).

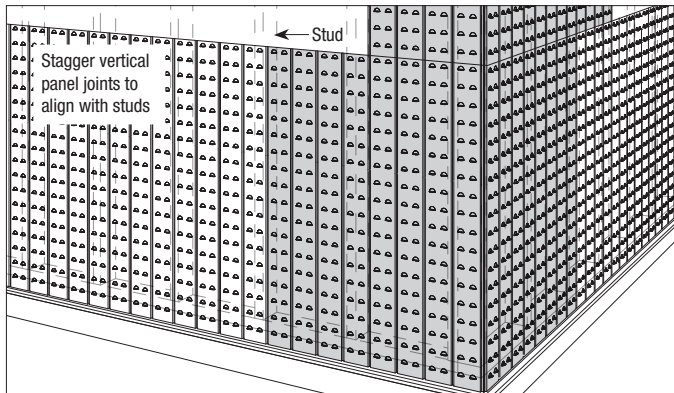

FIGURE 7

Cut panels where necessary to leave a 3/8 in. space around the perimeter of openings and objects fixed to the backup that will extend through the veneer.

BRICK/STONE INSTALLATION

Tools and Equipment:

ESSENTIALS

- Measuring tape
- Quart size caulking gun (for thin brick adhesive)
- Safety glasses
- Gloves
- Earplugs

OPTIONAL

- Extension cords
- 10 oz. caulking gun (for stone adhesive)
- Wheelbarrow
- Template for cutting or holding brick
- Wet saw for cutting brick or stone
- Ladders, scaffold, or jacks (OSHA approved)

Veneer units may vary in color, shade and texture. Mock-up panels are suggested prior to installation. Veneer units should be selected from 2 to 3 skids at one time to achieve a uniform distribution of normal variations in color range.

INSTALLING VENEER UNITS

- Layout first course of veneer units from corner to corner without adhesive to establish bond patterns with uniform joint thicknesses. Space units to reduce cutting at openings, movement joints, returns, and offsets. Cut multiple units within the length of the wall if necessary to prevent the installation of less than half size units.
- Apply dabs or beads of the supplied adhesive (and primer if required) to the back of veneer units as indicated in Table 4 and instructions in the

following sections. Apply no less than 2 dabs/beads of adhesive per unit at a maximum spacing of 6 in. Apply an additional dab of adhesive to the head of corner units. Primer/adhesive should not be applied within 1 in. of the edges of units to avoid staining (see Figure 8).

While extensive testing has been completed on Glen-Gery adhesive use with clay brick and other masonry units sold by Glen-Gery, there is a wide variety of proprietary concrete masonry units, natural and manufactured stone with various and variable physical properties. Therefore care should be taken when choosing a masonry unit to ensure it is compatible with available Thin Tech adhesives.

TABLE 4 - MINIMUM RECOMMENDED ADHESIVE QUANTITY

Unit length	Dabs/Beads of adhesive
Up to 12 in.	2
Over 12 in. to 18 in.	3
Over 18 in. to 24 in.	4

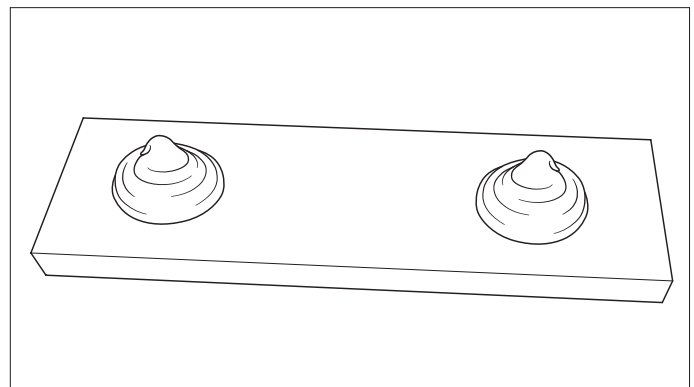

FIGURE 8

- Adhere brick beginning with the bottom course and continue up the wall. Install the corner units at end of the wall first, alternating the short and long ends of corners at each course, for running bond (see Figure 9).

ADHESIVE TIPS: Sliding the brick back and forth on the panel during installation increases the bonding area and strength of bond.

Too much adhesive may cause the brick to tilt forward away from the wall shortly after installation. These units may be properly reapplied within the recommended working time by pulling affected brick away from the panel for a few seconds to air the adhesive, then pushing them back into place. This allows solvent to escape faster and the adhesive to set more rapidly.

Comply with cold weather requirements of the building code when using adhesive at temperatures below 40°F.

Maximum temperature for adhesive installation is 120°F.

Adhesive holds the brick in place until the mortar has been installed and cured, providing a mechanical connection between the mortar, support ties and panel. The adhesive is not intended to be the primary connection between the brick and panel and should not be exposed for extended periods after the brick is installed. Mortar installation may begin after the adhesive has cured for no less than 6 hours. It is recommended that mortar installation be completed within one week of brick installation, and in no instance shall the installation remain incomplete for more than 15 days.

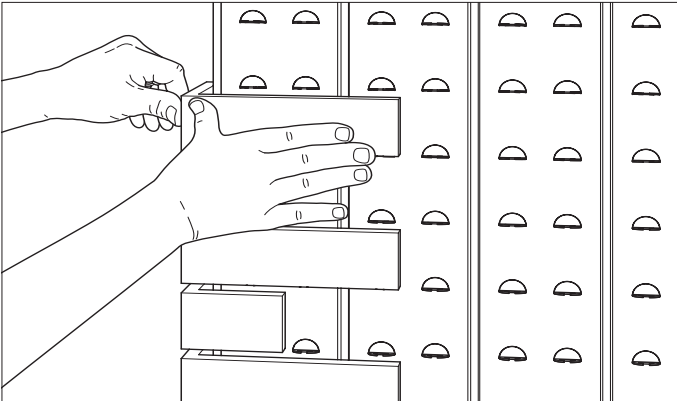

FIGURE 9

Glen-Gery does not recommend the use of thin brick corners that create horizontal ledges or returns exposed to the exterior; i.e. top of walls, window sills or at heads of openings. Use instead metal cap or similar, or a thicker stone or brick shape supported by a Thin Tech Channel (see Thin Tech hardware). In addition, starter angle/flashing may be required at the base of the projection.

For veneers not using corner units, begin alternating courses with full and half brick to create 1/2 running bond.

3/8 in. spacers may assist in keeping corner units in place while the adhesive sets.

Brick

- Back surface of the brick must be dry, clean and free of dirt, dust, or other material that may reduce bond prior to application of adhesive. Dry brushing cut units to remove loose material may be required prior to installation.
- Apply quarter-sized (1 in. diameter) dabs of Glen-Gery thin brick adhesive approximately 2 in. from each end of the brick and not more than 6 in. apart for brick greater than 8 in. in length (see Figure 8). See TABLE 4 (page 13) for recommended minimum quantity of adhesive. Apply an additional dab of adhesive to the head of corner units.
- Position the brick so that they rest securely on the support ties or starter angle and press firmly to adhere the brick to the support panel. Leave approximately 3/8 in. space between adjacent brick for the mortar joints.

Cast/Natural Stone

- Back surface of stone must be dry, clean and free of dirt, dust, or other material that may reduce bond prior to application of primer or adhesive.
- When primer is required, apply to the back of cast/natural stone units prior to application of structural silicone adhesive. Apply primer in vertical lines at least 1 in. wide. Provide a line of primer for each bead of structural silicone adhesive as recommended in TABLE 4 (page 13), at a maximum spacing of 6 in. and no less than two per unit. Primer should not be applied within 1 in. of the edges of units to avoid staining.
- Allow primer to dry completely (at least one hour) before applying structural silicone adhesive. Reapply primer if structural silicone adhesive is not applied within 8 hours.

Primer may be needed to enhance bond of adhesive to some cast/natural stone products. Contact stone manufacturer for guidance or conduct testing to determine if primer is necessary. Primer is moisture activated and requires additional drying time when relative humidity is below 50%.

- Apply structural silicone adhesive in 3/8 in. wide vertical beads to primed areas of cast/natural stone units and adhere unit to panel.
- Complete the first two courses to serve as a guide for the rest of the wall. Examine the work from a distance occasionally to ensure that the spacing of brick is consistent (see Figure 10).

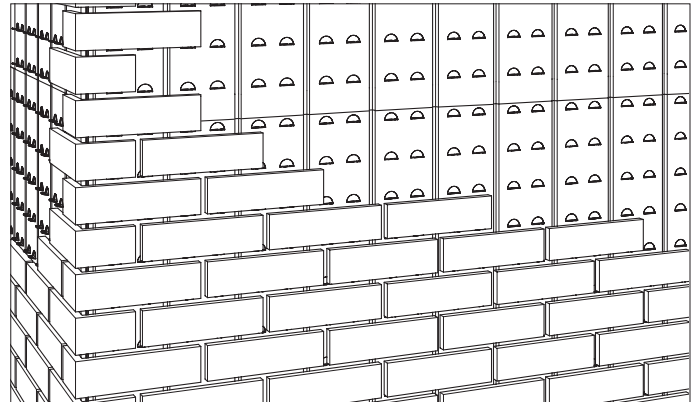

FIGURE 10

- Where movement joints occur between Thin Tech panels, leave a minimum 3/8 in. gap between brick units for backer and sealant (see Figure 11).

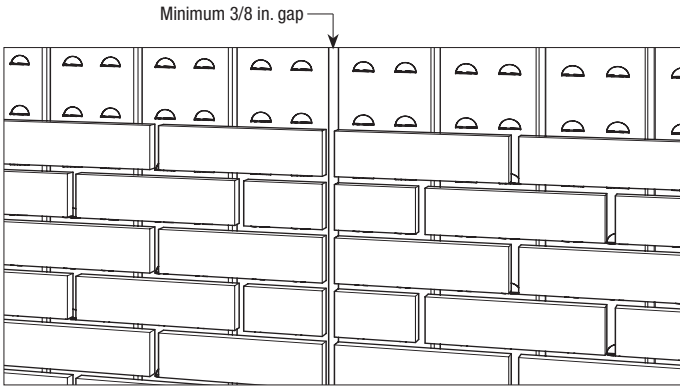

FIGURE 11

- At inside corners, maintain a 3/8 in. space between the end of each brick and the intersecting brick, panel or substrate surface (see Figure 12).

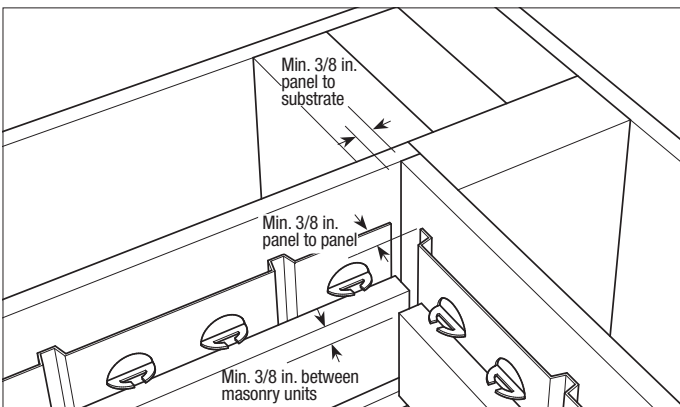

FIGURE 12

Leave at least 3/8 in. between brick and intersecting surfaces to accommodate movement.

CUTTING UNITS

- Masonry units should be cut with a wet saw or dust collecting circular saw with a masonry blade. Use protective eye wear, earplugs, respirator and gloves when cutting. A grinder may help when smaller more intricate cuts are required.
- Install cut units with uncut/finished edges exposed to view. Unfinished or cut faces should not be visible upon completion.

CAUTION: Masonry units contain crystalline silica. Prolonged exposure to dust may cause damage to the lungs. When working with this product, minimize creation of dust. Always use a NIOSH or MSHA approved particulate respirator. The practice of wet sawing is recommended.

INSTALLING A SOLDIER COURSE

- To create a soldier course, flatten rows of support ties that will be behind (but not above and below) the soldier course so that the brick can lie flat against the support panel and install brick vertically following procedure described above (see Figures 13 and 14).

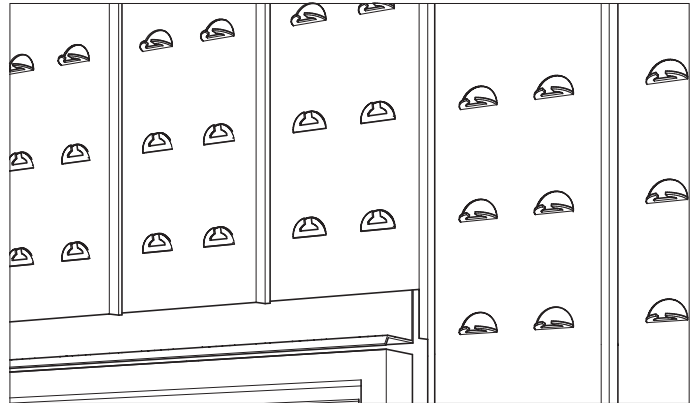

FIGURE 13

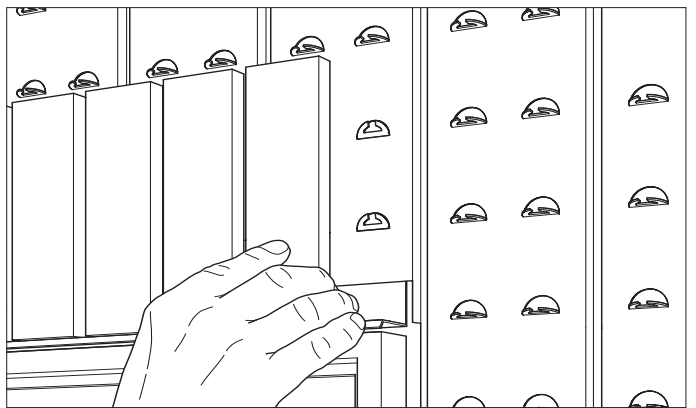

FIGURE 14

INSTALLING WEEPS OR AIR VENTS

- For exterior applications, form weeps immediately above all starter angle locations by omitting mortar in head joints at a maximum of 24 in. on center horizontally for units 12 in. or less in length and a maximum of 32 in. on center for larger units.
- Weep vents at least 1 in. high are required for *Elite* applications (See Figure 15) and may be used in lieu of open head joints for exterior *Classic* applications (see Figure 16). Apply a dab of adhesive to one end of the air vent (weep) and install vertically between brick with adhesive end at the top so that water drains at the bottom.

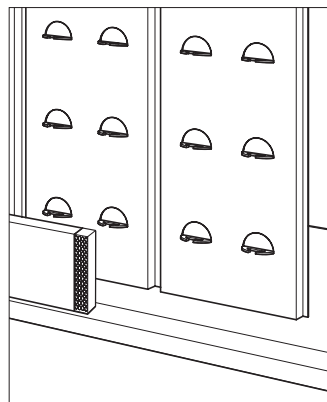

FIGURE 15

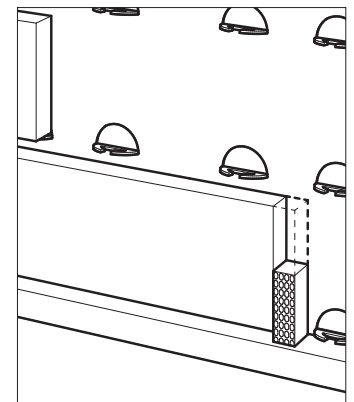

FIGURE 16

MORTAR INSTALLATION

Glen-Gery Color Mortar Blend consists of Portland cement, lime and approved pigments that meet ASTM C270 Type N by proportion specifications and ASTM-C270 Type S by property specifications. (See separate Glen-Gery Color Mortar Blend Technical Profile for additional information.) Glen-Gery Pre-Blended Mortar is also available for Thin Tech applications. Modified mortars meeting ANSI A118.4 and A118.15 have been known to improve performance and reduce cracking, particularly in stack bonded applications.

Allow adhesive to set for a minimum of 6 hours before filling joints with mortar.

For optimum mortar color uniformity, maintain consistency in mortar materials, mixing proportions and striking times.

Materials and Tools

- Sand
- (2) 4 gallon clean buckets
- Water
- Mortar mixer
- Drill
- Mortar Jointer
- Mortar (ASTM C270 Type N or S, or ANSI A118.4 or A118.15)
- Dust mask
- 1/4 in. screen
- Mixing measuring device
- Margin trowel
- Mixing paddle/Mortar whip
- Stiff bristle brush
- Mortar bags with metal tips or mortar gun

Batching and Mixing

- Mix 2-1/4 parts sand meeting the requirements of ASTM C144 to 1 part Glen-Gery Color Mortar Blend and the maximum amount of water that produces a workable consistency following product mixing instructions.

Dry screening the sand and cement prior to mixing may help to remove any clumps or large particles that would clog the mortar bag or gun.

Reducing the sand content to the minimum ASTM C270 proportions for Type S or N has proven to ease mortar installation with a mortar bag. Portland cement-lime mortar and modified mortars meeting ANSI A118.4 and A118.15 have also proven to be easier to install with a mortar bag than pre-blended mortar.

Polymer additives may be added to Portland cement-lime mortar as a means improving plastic or hardened properties of mortar.

Glen-Gery does not recommend the use of accelerators or set retarding additives. When temperatures are below 40°F or above 90°F follow the cold or hot weather provisions of TMS 602. Additional information on hot and cold weather construction is available from your local Glen-Gery representative.

- The mix should have a smooth, creamy appearance. Mortar that is too dry will be difficult to push through a mortar bag. Mortar that is too wet may sag out of the joints making striking and cleanup difficult. Be sure to let the mix set for 5 minutes to properly wet all mortar constituents and allow for proper hydration prior to determining proper consistency.

Beginning Mortar Application

- For mortar bag installation – fold down the open end of the mortar bag approximately 1/3 of the way. Fill half of the mortar bag and shake the mortar down the bag until liquid flows to the top of the mix. Twist and squeeze the empty portion of the bag slightly above the mix to eliminate any trapped air. Observe the flow through the tip of the bag; if the entire flow is smooth and consistent then it is ready to be applied onto the brick wall.

Plastic mortar bags have been proven popular due to reduced pressure needed to properly install mortar and a metal tip has proven to reduce the need to replace the bag. Common practice for ease of installation suggests filling the horizontal (bed) joints when the mortar bag is filled and moving to the vertical (head) joints as the bag empties.

- Fill the joints with mortar working up from the bottom of the wall.
- Work your way up in a pyramid fashion. Place the bag or gun at horizontal angle of approximately 45 degrees to the wall and fill 4 or 5 linear feet of bed (horizontal) joints first. Squeeze and twist the bag for an even and uniform flow of mortar from the tip of the bag. Slightly over-fill joints (so that mortar bulges out) to counter drying shrinkage and ensure full joints after striking (see Figure 17). Fill head (vertical) joints after every 3 or 4 bed joints.
- Discard mortar after two hours or when too stiff to work. Retempering within two hours is permitted, but may contribute to mortar color variation.

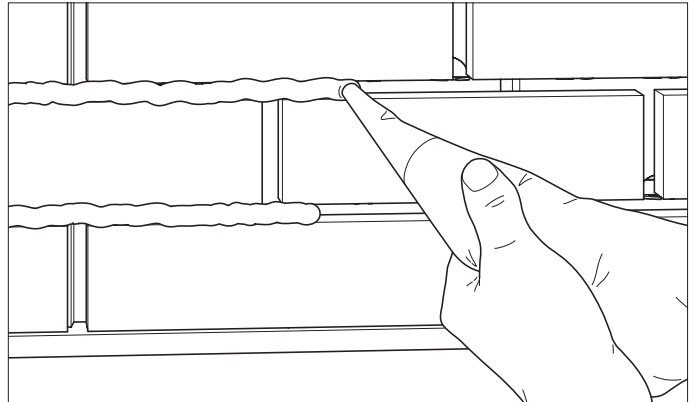

FIGURE 17

Placing the mortar bag or gun at an angle to the wall permits joints to be more quickly and easily overfilled.

Working up the wall in a pyramid fashion has proven helpful in preventing noticeable color variation.

Striking/Tooling the Joints

- Setting time will depend on temperature and humidity. In very hot weather, it may be helpful to dampen brick or stone to slow moisture absorption from mortar and allow for proper mortar hydration.
- Use a jointer/striker to tool joints when the mortar becomes thumbprint dry to the touch (when pressing a thumb in the mortar leaves a print, but mortar does not transfer to your thumb). Continue this process up the wall, always checking to see if the previously applied mortar is ready to be tooled with the brick jointer.
- Common practice suggests striking the vertical (head) joints first, followed by the horizontal (bed) joints so that the horizontal joint shows a consistent profile. Striking may be accomplished by either pushing forward with the back side (heel) of the jointer or pulling backward with the front side of the jointer (see Figure 18). All joints must be completely filled. If necessary, mortar struck from the wall may be used to fill small voids.
- Struck/tooled mortar should be dry enough to fall away clean and tooled to a dull, gritty finish (not wet and shiny).

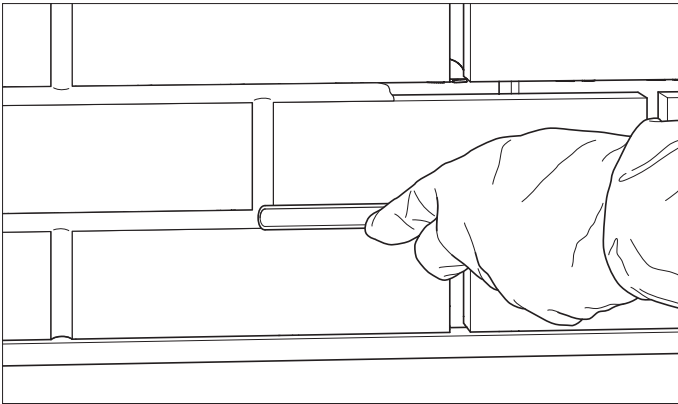

FIGURE 18

Thin hairline cracks can occur in the mortar joints for several reasons including early striking, excess water in the mortar mix, not enough sand in the mix (cement rich), rapid mortar curing in extremely hot, dry weather, and movement of the substrate. These small cracks do not typically affect the performance of the product and can be minimized by striking at the appropriate time, using a proper mortar mix, and in weather above 100°F, fogging joints daily for several days following mortar installation to extend the curing process.

Avoid subjecting walls to impact from within due to drywall or cabinet installation for one week after grouting/mortar installation. Allow prefabricated walls systems to set after mortar installation for a minimum of one week prior to shipment.

- When the mortar is dry on the surface, lightly brush the wall diagonally with a non-metallic, long bristle brush to remove excess mortar. This is often done before lunch and at the end of the day or prior to moving scaffolding – If mortar is smearing on the face of the brick or on the brush then wait longer before brushing the wall.

- If additional cleaning is needed, follow brick/stone manufacturer's cleaning instructions. Glen-Gery Corporation recommends cleaning brick between 7 and 10 days. BIA Technical Note #20 offers additional cleaning guidelines for brick products. Consult stone manufacturer for stone cleaning recommendations.

Cleaning the Veneer

CAUTION: PLEASE USE THE RECOMMENDED CLEANER AND PROCEDURE AS PER THE BRICK /STONE MANUFACTURER'S SPECIFICATIONS AND IN ACCORDANCE WITH THE CLEANING PRODUCT MANUFACTURER'S INSTRUCTIONS. DO NOT USE MURIATIC OR HYDROFLOURIC ACID.

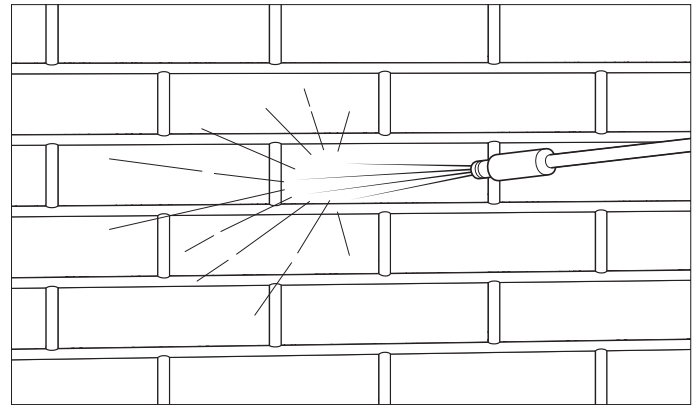

FIGURE 19

For any questions or concerns please call 800-854-4780.

- All manufacturer approved components of the Glen-Gery Thin Tech System (see warranty) must be purchased through an authorized dealer and installed by a Glen-Gery trained installer for warranty to be valid.

Appendix A – Mortar Estimating Table

Thin Tech Mortar – Approximate Mortar Coverage									# bags of pre-blended ^a		# bags CMB (mixed 1 to 3 with sand) ^b		# bags CMB (mixed 1 to 2-1/4 with sand) ^c	
Mortar yield calculations based on brick size/thickness and cement/sand ratio									Per 100 sq. ft.	Per 1000 brick	Per 100 sq. ft.	Per 1000 brick	Per 100 sq. ft.	Per 1000 brick
Height (brick only)	Nominal height (brick plus mortar joint)	Specified length	Thin brick size	Thin brick thickness		Thin brick units per sq. ft.	Cu. ft. mortar needed/ 100 sq.ft.	Cu. ft. mortar needed/ M brick						
2-3/4	3-1/5	7-5/8	Queen	3/4	5 courses per 16 in.	5.63	1.19	2.11	1.53	2.71	0.40	0.70	0.53	0.94
2-1/4	2-2/3	7-5/8	1/2 Modular	1/2	3 courses per 8 in.	6.75	0.84	1.25	1.08	1.60	0.28	0.42	0.42	0.56
2-1/4	2-2/3	7-5/8	3/4 Modular	3/4	3 courses per 8 in.	6.75	1.27	1.88	1.62	2.41	0.42	0.63	0.63	0.83
2-3/4	3-1/5	7-5/8	1/2 Engineer Modular	1/2	5 courses per 16 in.	5.63	0.79	1.41	1.02	1.81	0.26	0.47	0.47	0.63
2-3/4	3-1/5	7-5/8	3/4 Engineer Modular	3/4	3 courses per 8 in.	5.63	1.19	2.11	1.53	2.71	0.40	0.70	0.70	0.94
3-5/8	4	7-5/8	Econo	3/4	1 course per 4 in.	4.50	0.85	1.89	1.09	2.43	0.28	0.63	0.63	0.84
2-1/4	2-2/3	8	Standard	3/4	3 courses per 8 in.	6.55	1.27	1.94	1.63	2.49	0.42	0.65	0.65	0.86
2-3/4	3-1/5	8	Engineer Standard	3/4	5 courses per 16 in.	5.39	1.18	2.19	1.51	2.80	0.39	0.73	0.73	0.97
2-3/4	3-1/5	8-1/2	Handmade Oversized	1	5 courses per 16 in.	5.00	1.52	3.05	1.95	3.91	0.51	1.02	1.02	1.35
2-3/4	3-1/5	9-5/8	King	3/4	5 courses per 16 in.	4.55	1.14	2.50	1.46	3.21	0.38	0.83	0.83	1.11
2-1/4	2-2/3	11-5/8	Norman	3/4	3 courses per 8 in.	4.50	1.17	2.61	1.50	3.34	0.39	0.87	0.87	1.16
3-5/8	4	11-5/8	Utility	3/4	1 course per 4 in.	3.00	0.76	2.54	0.98	3.26	0.25	0.85	0.85	1.13
2-3/4	3-1/5	11-5/8	Kingston	3/4	5 courses per 16 in.	3.75	1.09	2.90	1.39	3.71	0.36	0.97	0.97	1.29

Table includes actual mortar required in the joints and includes no waste factor. A minimum of 5% waste should be added for actual project quantity estimates.

ASTM C270 Standard Specification for Mortar requires sand ratio of not less than 2-1/4 and not more than 3 times the sum of cementitious materials. Mortar for full brick applications typically use cement/sand ratio of 1:3 – Glen-Gery has found that a 1:2-1/4 mix ratio may ease installation when mortar is installed with grout bag. For additional information see Glen-Gery Thin Tech Installation Instructions.

^a Glen-Gery Pre-blended Portland cement lime mortar with sand in one bag.

^b Glen-Gery Color Mortar Blend – cementitious material in bag, sand to be added – typical C270 cement/sand ratio 1:3.

^c Glen-Gery Color Mortar Blend – typical C270 cement/sand ratio 1:2-1/4 recommended when utilizing a grout bag to fill thin brick joints.

Appendix B – Determining the Base Starter Angle Position

- When determining the location of the starter angle, in order to reduce the need for cut units above openings, aligning the masonry unit coursing so that the units above the opening do not need to be cut is recommended. If a full course is not possible, consider rowlocks, soldiers or trim pieces.
- The position of the starter angle at the base of the wall may be adjusted to ensure full coursing between the top of the window/opening and the bottom of the wall. In order to ensure course alignment at the top of the

opening, the distance between the top of the starter angle above the window and the top of the starter angle at the base of the wall must be a multiple of the course height (masonry unit height plus bed joint thickness, also known as nominal height) to avoid cutting units horizontally. The table below indicates the nominal height of a course for each unit size.

Size	Modular, Standard, Norman	Modular, Standard, Norman	Engineer, Handmade Oversize	Econo, Utility	8-Square			
Unit Height	2-1/4 in.	2-1/4 in.	2-3/4 in.	3-5/8 in.	7-5/8 in.	11-5/8 in.	15-5/8 in.	23-5/8 in.
Course Height (Nominal Height)	2.667 in.* (3 courses = 8 in.)	2.625 in.** (3/8 in. mortar joint)	3.2 in.	4.0 in.	8.0 in.	12.0 in.	16.0 in.	24.0 in.

*Recommended for 2-1/4" high units to achieve traditional modular vertical coursing.

**Due to the precise and consistent spacing of Thin Tech support ties, panels with 2-5/8 in. coursing (true 3/8 in. joints) will not align with modular 8 in. vertical coursing (3 courses = 7-7/8 in.). Although the dimension typically specified for mortar joints is 3/8 in., the actual width of bed joints in modular masonry is closer to 7/16 in. and is adjusted as needed to accommodate masonry unit dimensional variation and achieve 8 in. vertical modular coursing.

Example: The bottom of the utility brick course (top of support tie) above a window is 87 in. above grade. Subtract 4 in. for the required height above grade and divide by 4, the nominal height of the brick (unit plus mortar). $83 \text{ in.} \div 4 \text{ in.} = 20.75$. Therefore there are 20 full utility size thin brick courses (3-5/8 in. high unit + 3/8 in. joint) between the top of the opening and 4 in. above grade. Measure and mark 80 in. (20 courses x 4 in.) below the bottom of the utility brick course as the location of the horizontal leg of the starter angle.

Appendix C – Thin Tech Corner Support Design Guide

Installation Overview

With metal or wood framed applications, Thin Tech panels must be fastened to the wall framing (studs). While most framing is spaced on 16 in. centers, the stud spacing is typically set from the interior at one end of the wall. Because the distance to the opposite corner is not always an exact multiple of 4 in., channels in the Thin Tech *Elite* panels may not align with the stud location at a corner, see Figure C-1 (below).

As indicated in Figure C-1, even without continuous insulation, additional corner framing may be necessary to ensure that panels can be fastened through a channel to a stud at the corner. While there are various configurations that can be used to frame a corner, energy concerns often reduce the framing installed at the corners, in some instances opting for varying framing details as well as the use of clips instead of the additional stud usually installed at typical three stud corners as indicated in Figure C-2 (next page).

In addition, walls designed to meet IECC requirements often include the use of rigid insulation between the Thin Tech panel and the sheathing. Such applications increase the distance that panels extend beyond the last supporting stud at corners and alter the location of the *Elite* Panel channels relative to the actual stud location, see Figure C-2 (next page).

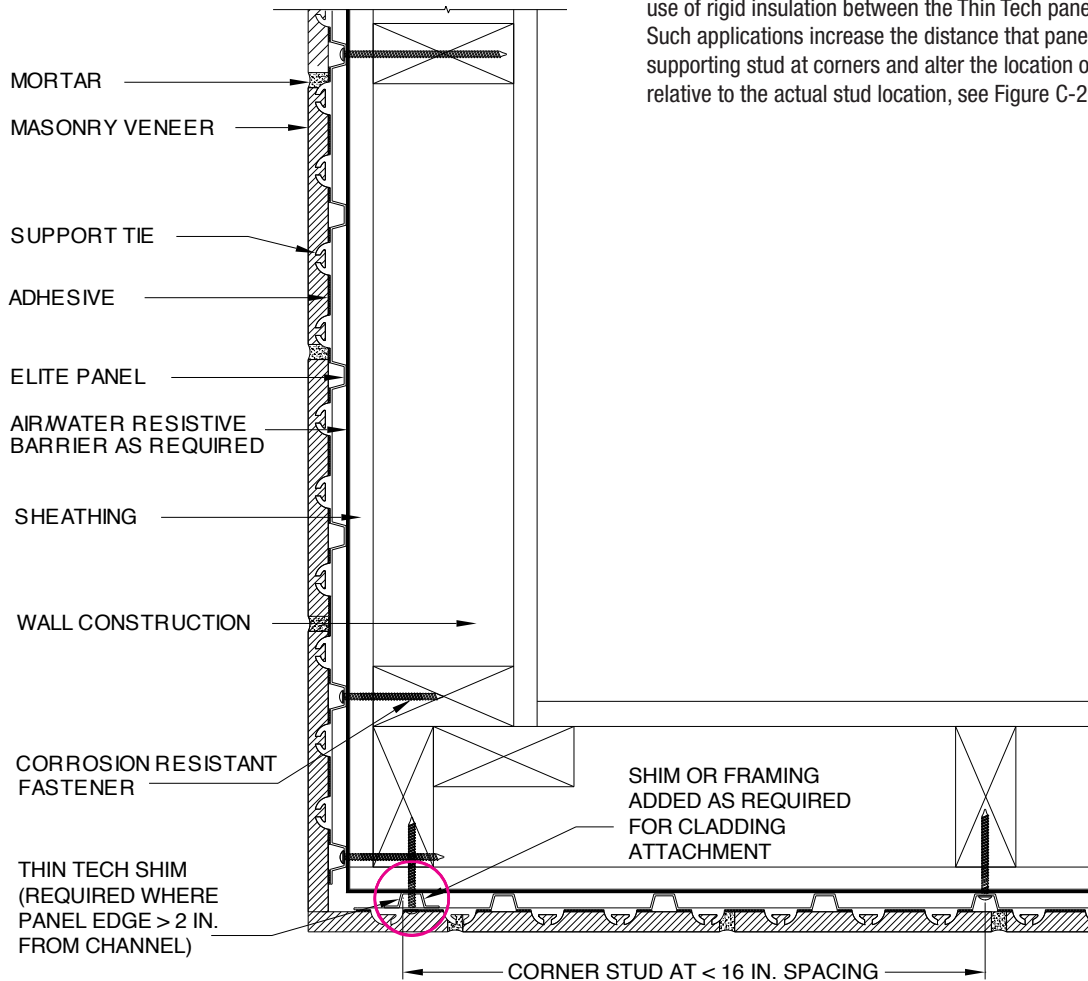

FIGURE C-1 – PLAN VIEW AT CORNER

Thin Tech corner supports are 4 ft. tall with 6 in. horizontal legs manufactured from the same 26-gauge galvanized/coated metal as the Thin Tech panels. The 6 in. legs allow attachment of the corner support to the framing with a wide variety of wall system configurations. The corner support is positioned vertically, covering the substrate or insulation at the corner, and fastened to the stud on each side of the corner at a maximum spacing of 8 in. vertically with corrosion-resistant #10 self-drilling, pan-head, corrosion resistant fasteners long enough to penetrate metal studs by at least three threads, wood studs by 1-1/4 in. or masonry/concrete by 1 in.

Fasteners must be no farther than 4-1/2 in. from the bend in the corner support, thereby limiting the thickness of continuous insulation to 3 in. in typical applications.

Position Thin Tech shims to support *Elite* panel edges where cutting results in unsupported flat sections that extend more than 2 in. beyond a channel. A single fastener is typically sufficient to initially secure a shim to the corner support, since the fasteners used to attach the Thin Tech panel to the corner support should also pass through the shim.

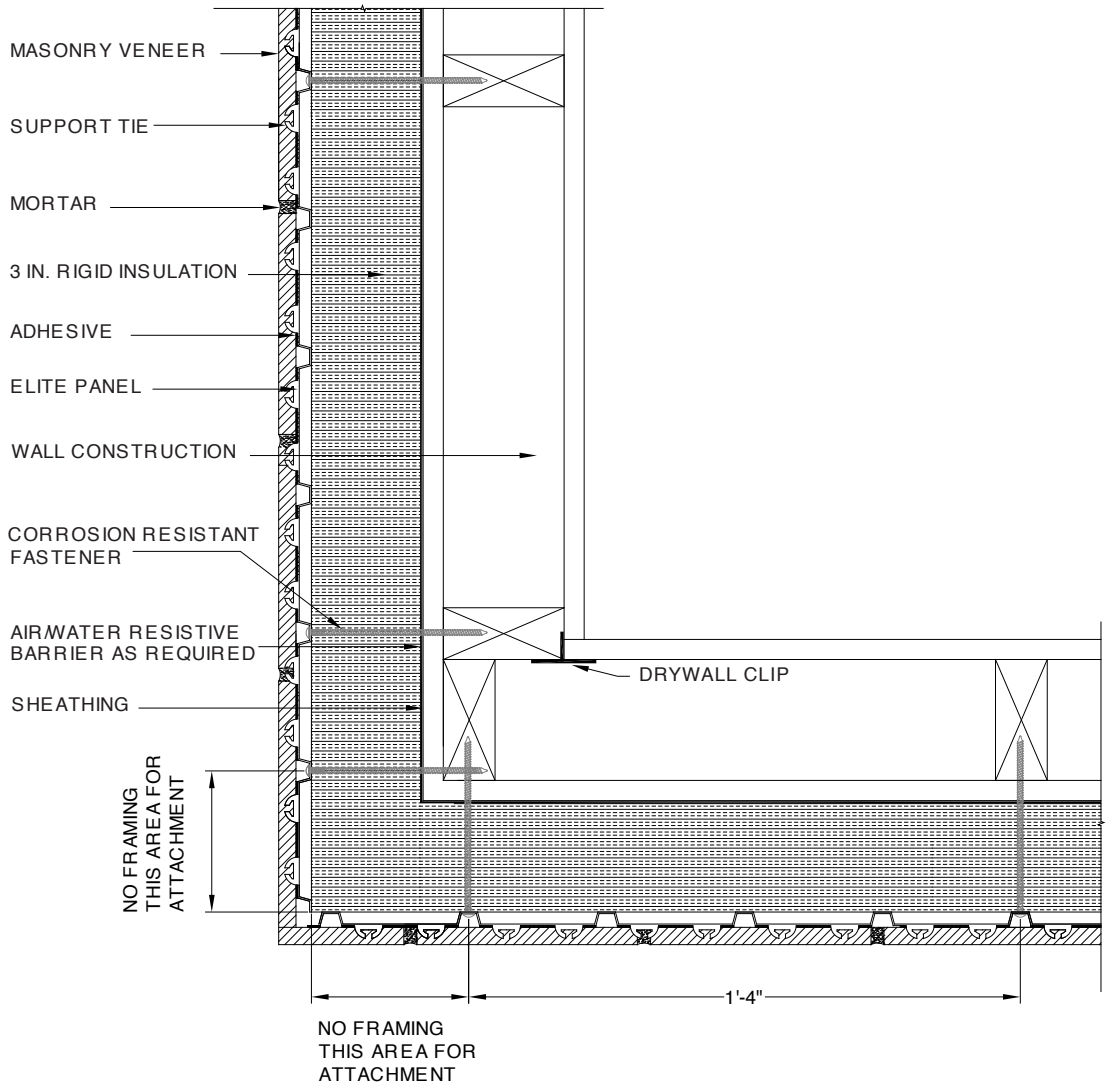

FIGURE C-2 – PLAN VIEW AT 2-STUD CORNER

Thin Tech flat panels are installed over corner supports (and shims where applicable) and fastened to the corner supports, as indicated in Figures C-3 through C-8, every 8 in. vertically with fasteners at least 1/2 in. long (1 in. long where a panel is attached over a shim as indicated in Figures C-6 and C-7). This configuration allows the corner support to be attached to the framing and the flat panels to be fastened to the corner support,

providing transfer of lateral wind load to the framing in most common corner configurations. Glen-Gery supplies fasteners to ensure proper attachment to corner supports, including fastening panels to corner supports through shims.

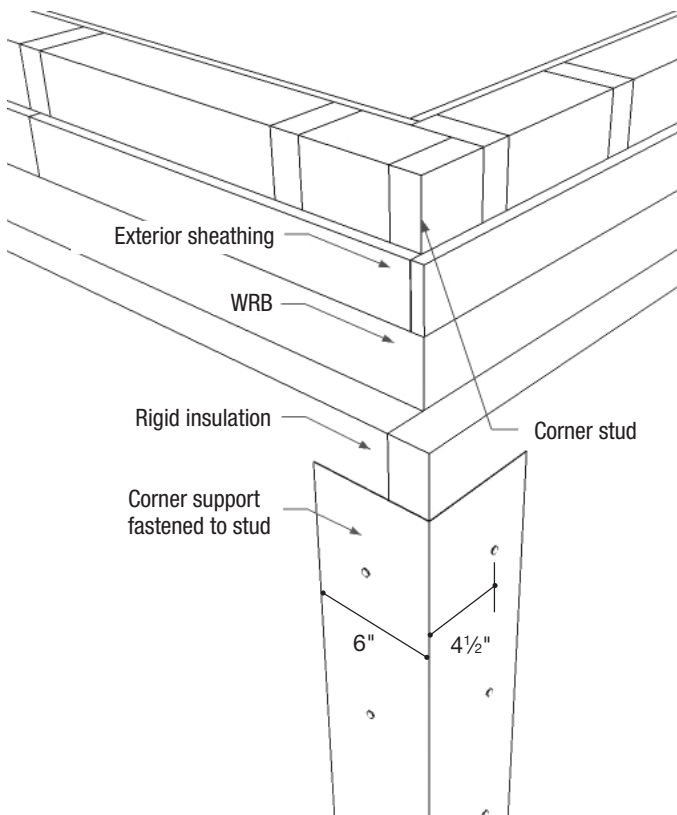

FIGURE C-3 – CORNER SUPPORT FASTENED THROUGH INSULATION

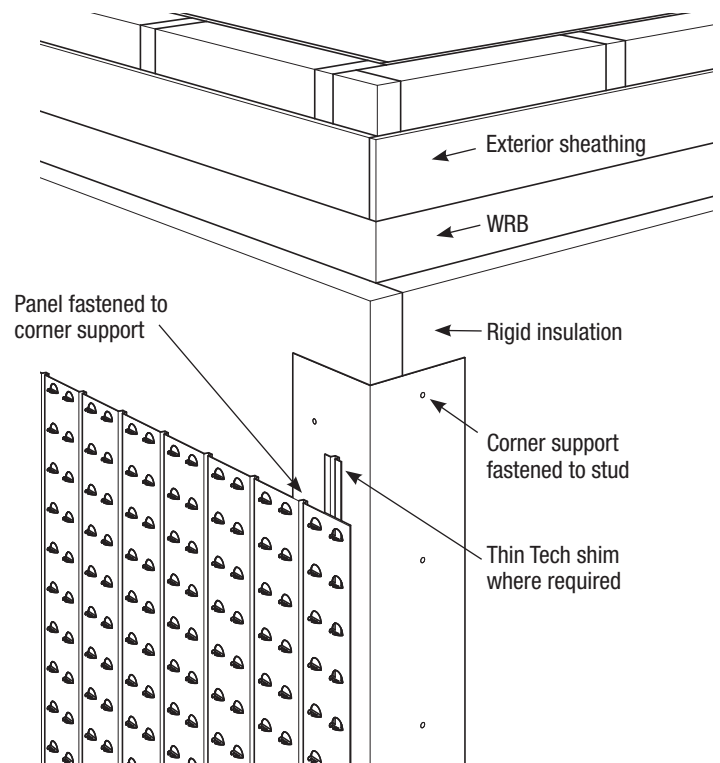

FIGURE C-4 – FLAT PANEL ATTACHED TO CORNER SUPPORT

Corner supports may also be used for internal corner applications; however the fastener hole in the bend should be pre-drilled to ensure proper embedment into the framing at the corners. Fasteners installed diagonally at inside corners must be longer than at other conditions to achieve the required embedment. See Table, page 26 for recommended minimum lengths. Once the corner support is properly attached to the corner framing,

the Thin Tech flat panels should be fastened to the internal corner support, no further than 4 in. from each side of the bend, as shown in Figure C-8 (see page 7). Leave a minimum 3/4 in. space between perpendicular panel edges at inside corners to accommodate the brick thickness and material movement.

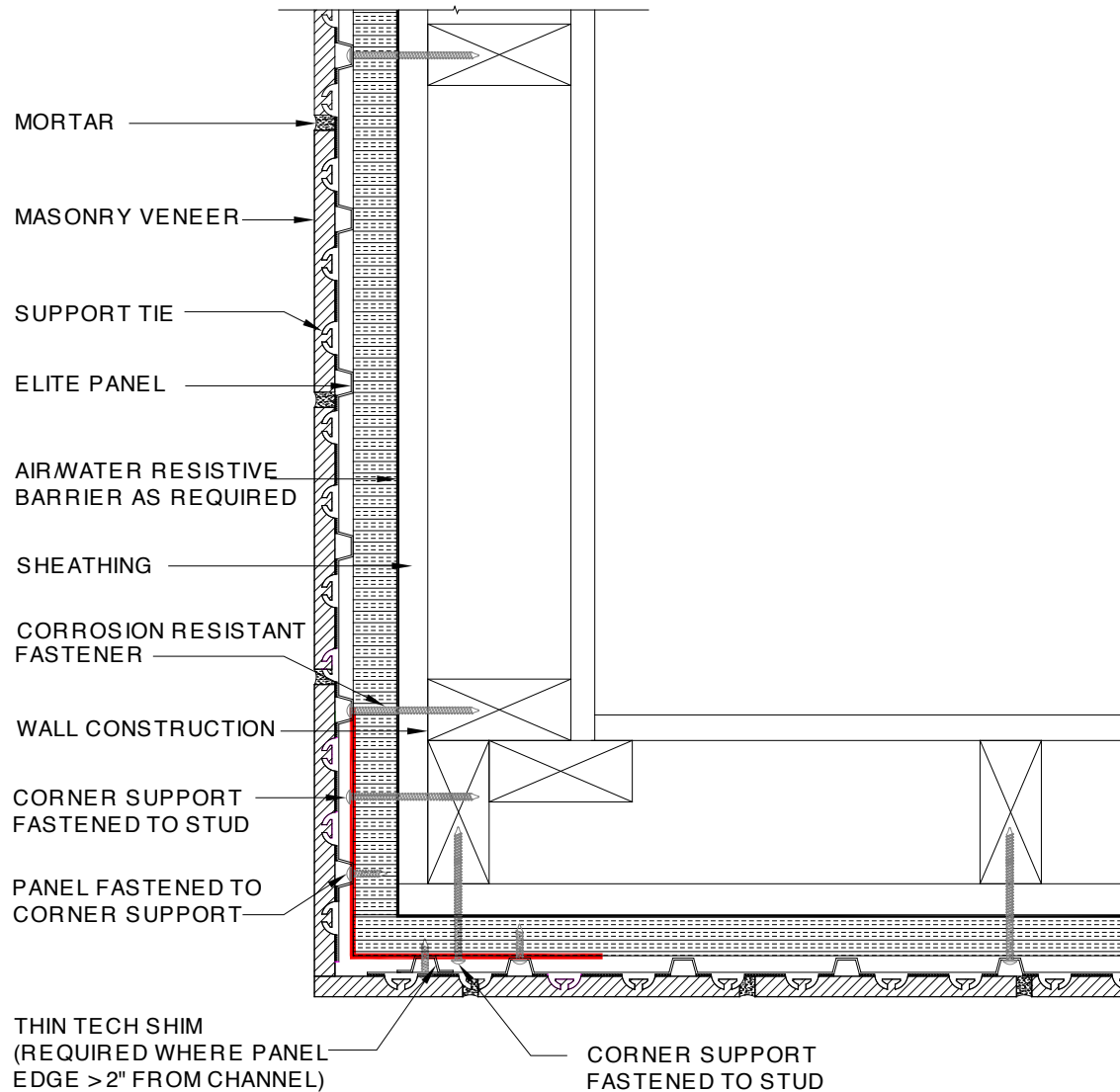

FIGURE 5 – 6 IN. THIN TECH CORNER SUPPORT

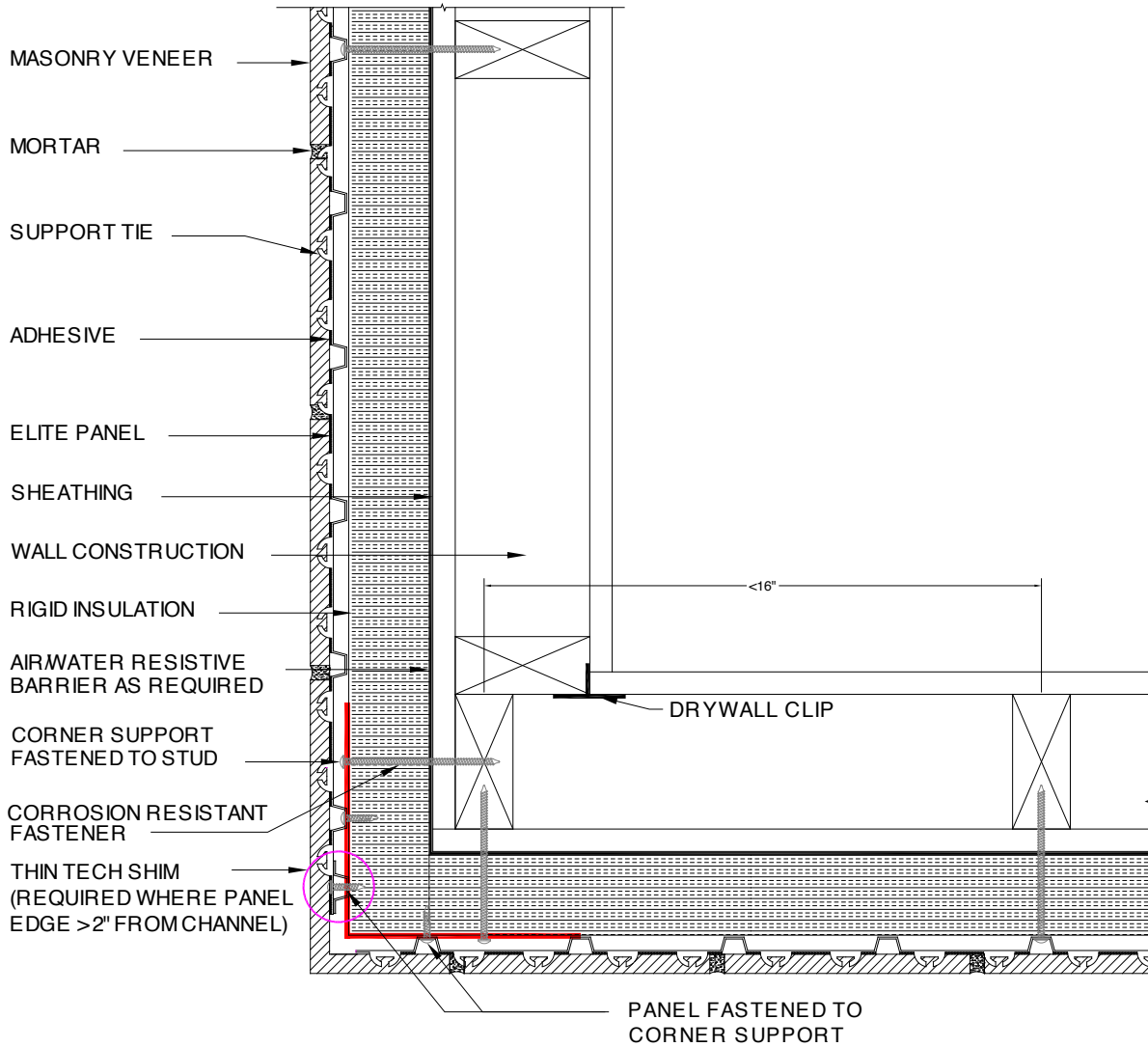

FIGURE C-6 – CORNER SUPPORT ON 2 STUD CORNER WITH 2 IN. INSULATION AND THIN TECH SHIM ADDED AS SUPPORT

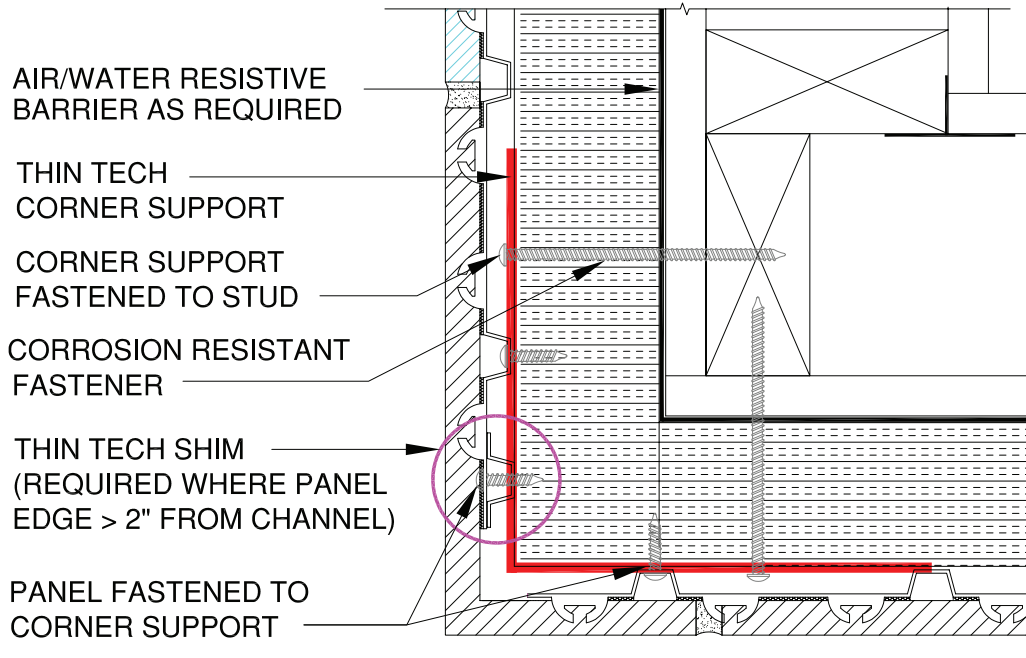

FIGURE C-7 – CORNER SUPPORT ATTACHMENT DETAIL

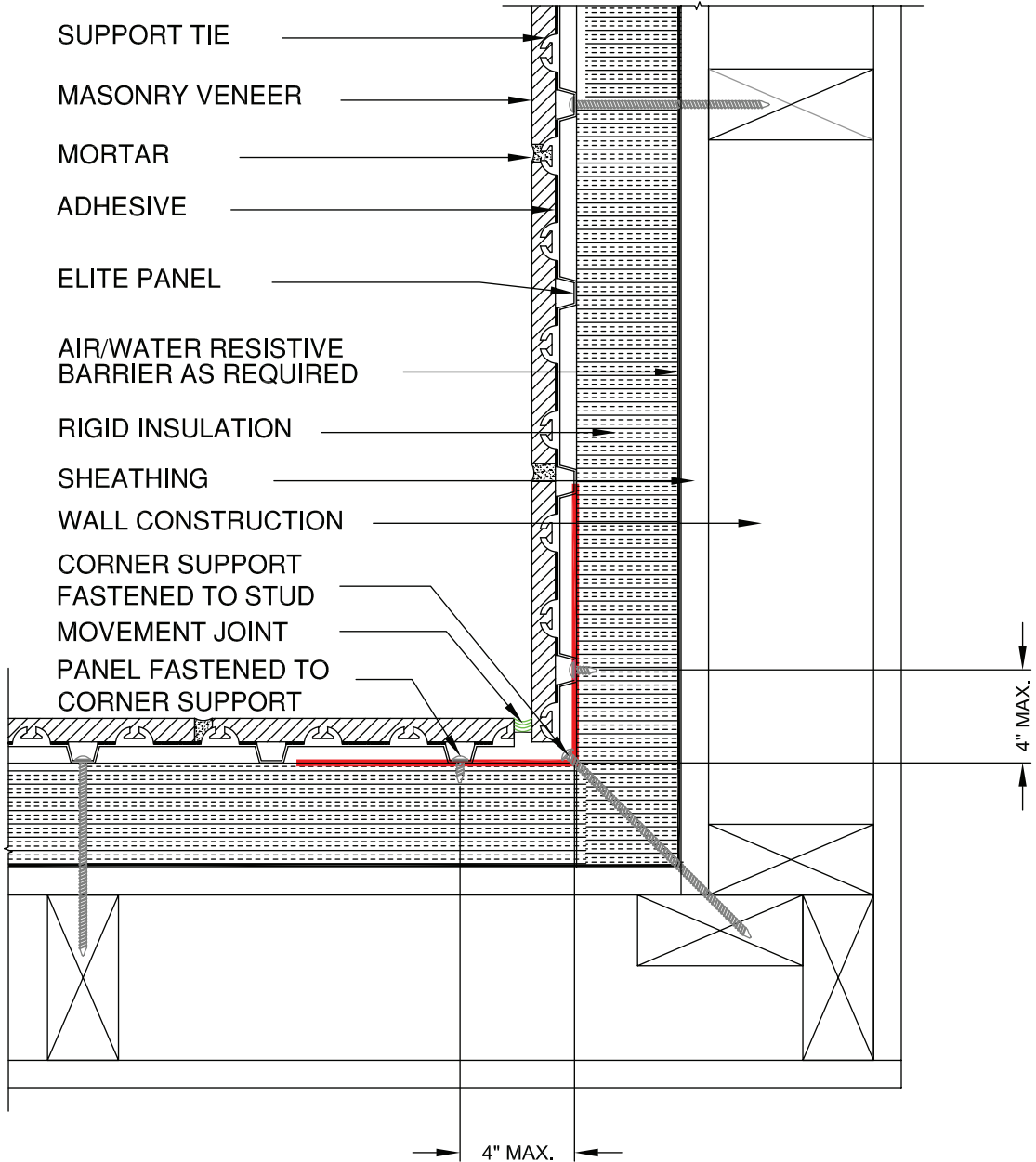

FIGURE C-8 – CORNER SUPPORT AT INSIDE CORNER WITH 2 IN. INSULATION

MINIMUM DIAGONAL FASTENER LENGTH AT INSIDE CORNER^a

Continuous Insulation Thickness	Application	
	Steel Framing	Wood Framing, Concrete or Masonry
0	1-1/2 in.	2-1/2 in.
1	3 in.	4 in.
2	4-1/2 in.	5-1/2 in.
3	6 in.	7 in.
4	7-1/2 in.	8-1/2 in.

^aFor 7/16 in. to 5/8 in. sheathing thickness

Estimating

The number of corner supports required for a particular project can be determined by dividing the linear feet of exterior and interior corners where corner supports will be used by 4 and adding a minimum 5% waste/unplanned usage factor. The corner supports are designed to replace the previously available pre-bent corner panels, making it easier to securely fasten panels with more framing and insulation configurations. To adjust estimates from use of pre-bent corner panels to the new corner supports simply add a number of flat panels and corner supports equal to the number of pre-bent corner panels estimated.

- Thin Tech wall panels and the pre-bent corner panels covered the same amount of area, so the square footage previously covered by pre-bent corners, will now be covered by wall panels ending at the corner. Adjust the number of wall panels to replace the number of pre-bent corner panels.
- Corner supports span the same height (4 ft.) as pre-bent corner panels; therefore the total linear footage (height) of corner supports needed is the same as the number of pre-bent corner panels estimated.



Discover the possibilities at glengery.com

A brand of

BRICKWORKS
— BUILDING PRODUCTS —

Due to printing limitations, color and texture may vary from actual product. Final selection should always be based on an actual product sample. For more information, contact your Glen-Gery representative. © 2020 Glen-Gery Corporation • 6/20/LSD